

Hur stor är volymen? (I)

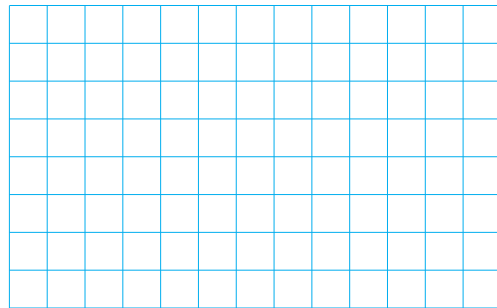

3 a)

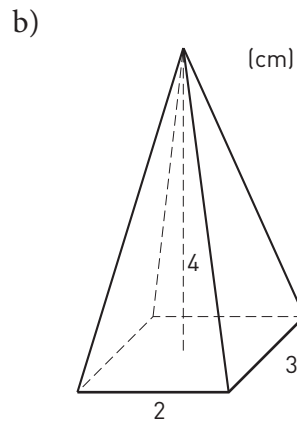
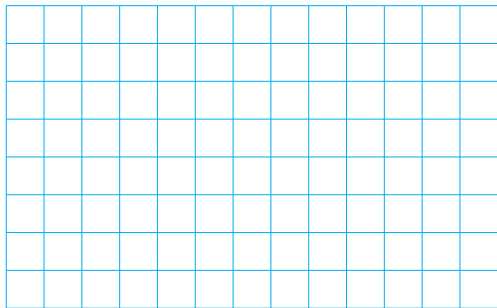
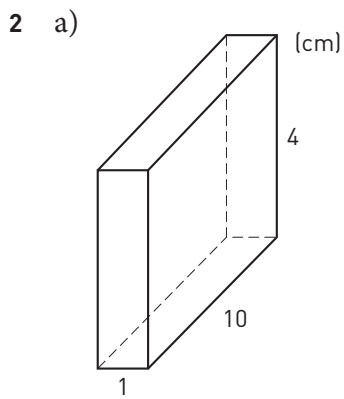
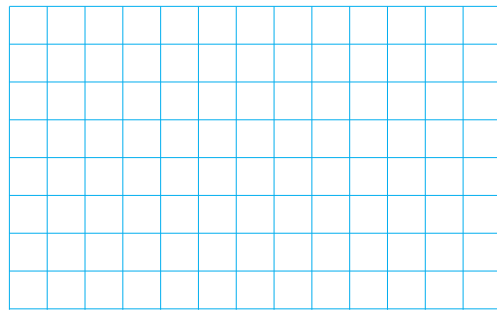
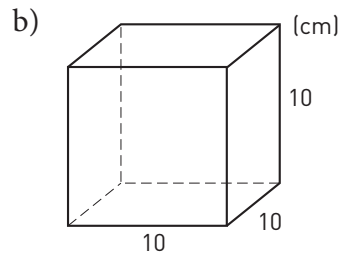
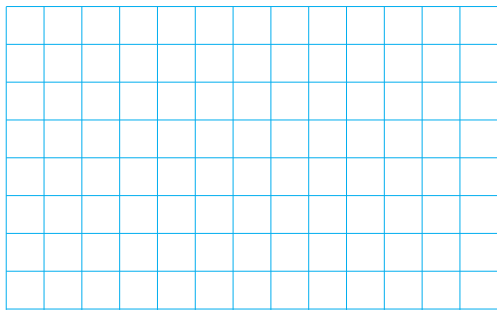
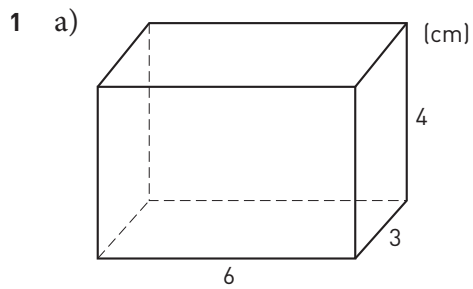
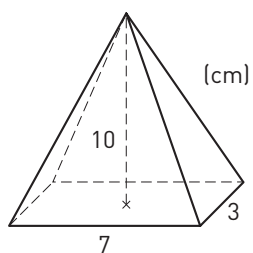

\_\_\_\_\_

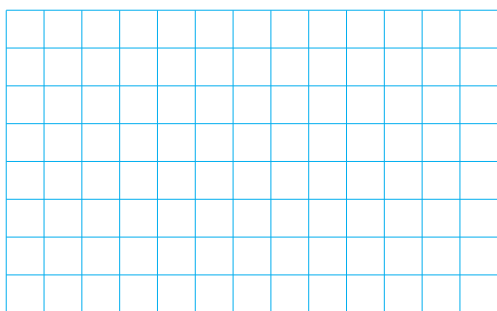

b)

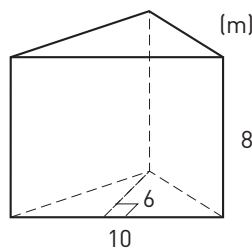

\_\_\_\_\_

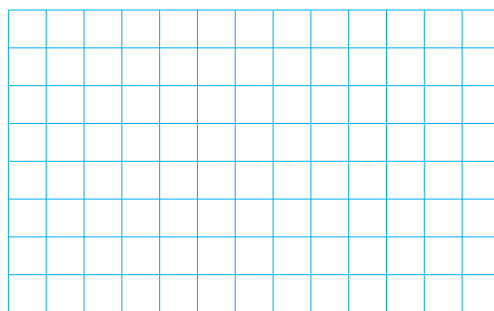

4 a)

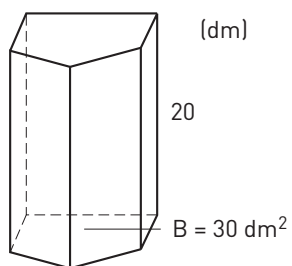

\_\_\_\_\_

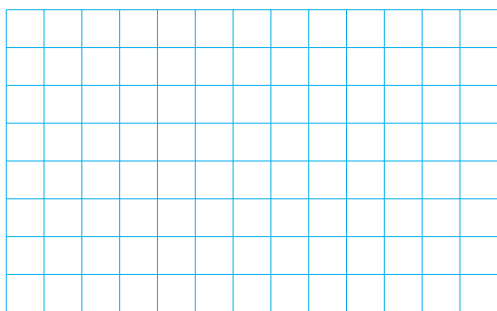

b)

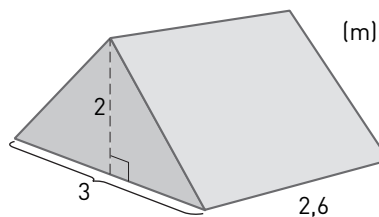

\_\_\_\_\_

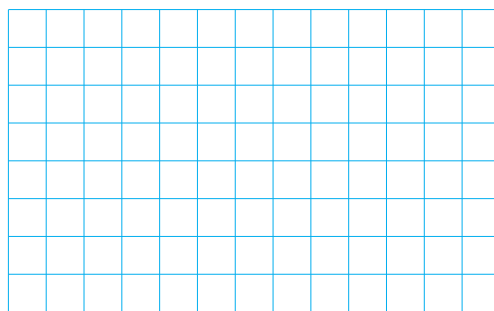

**Hur stor är volymen? (I)****FACIT**

- 1 a)  $72 \text{ cm}^3$   
b)  $1\,000 \text{ cm}^3$
- 2 a)  $40 \text{ cm}^3$   
b)  $8 \text{ cm}^3$
- 3 a)  $70 \text{ cm}^3$   
b)  $240 \text{ m}^3$
- 4 a)  $600 \text{ dm}^3$   
b)  $7,8 \text{ m}^3$